

LB-SJ-180670-1.85F Broadband Dual Polarization Horn Antenna
18-67GHz 15dB Gain 1.85mm Female



Broadband Dual Polarization Horn Antenna Operating From 18GHz to 67GHz With a Nominal 15dB Gain With 1.85mm Female Connector

Product Information

SKU	LB-SJ-180670-1.85F	Patents	US D1006799 (USA) ZL202030750673.5 (China) ZL202110169216.0 (China) ZL202120347928.2 (China)
-----	--------------------	---------	---

Description

Broadband Dual Polarization Horn Antenna LB-SJ-180670-1.85F, operating from 18 to 67GHz with a nominal 15dB gain and low VSWR 1.8:1 with 1.85mm Female output connector. The model LB-SJ-180670-1.85F has uniform gain through its frequency span, providing efficient performance characteristics and directionality. It can handle 5W continuously and 10W peak power. Constructed of lightweight corrosion-resistant aluminum, the antenna will provide years of trouble-free indoor and outdoor service. This horn antenna has dual linear polarization and ideally suited for EMI testing, direction finding, surveillance, antenna gain and pattern measurements and other applications.

Technical Specification

Electrical Specification		Interface	
Frequency, Min (GHz)	18	Output Type	Coaxial
Frequency, Max (GHz)	67	Connector	1.85mm(V)
Gain, Typ (dBi)	15	Connector Gender	Female
Polarization	Dual Linear	Mechanical Specification	
3dB Beamwidth, E-Plane, Min (Deg.)	17	Body Material	Al
3dB Beamwidth, E-Plane, Max (Deg.)	44	Finish	Gold Plated, Gray Paint
3dB Beamwidth, H-Plane, Min (Deg.)	16	Size, W (mm)	33.9
3dB Beamwidth, H-Plane, Max (Deg.)	55	Size, H (mm)	33.9
Cross Pol. Isolation, Min (dB)	20	Size, L (mm)	61.5
Cross Pol. Isolation, Typ (dB)	30	Weight, (kg)	0.07
Port to Port Isolation, Min (dB)	25		
Port to Port Isolation, Typ (dB)	35		
VSWR, Typ	1.80:1		
VSWR, Max	2.20:1		
Impedance, (Ohm)	50		
Power Handling, CW, (W)	5		
Power Handling, Peak, (W)	10		

Additional Information

Solution for	Antenna Measurement Reflector Feed Far-field Measurement Planar Near-Field Measurement Cylindrical Near-Field Measurement Spherical Near-Field Measurement CATR System Intergration
--------------	--

Outline Drawing

1.85mm-Female Output (P/N: LB-SJ-180670-1.85F)

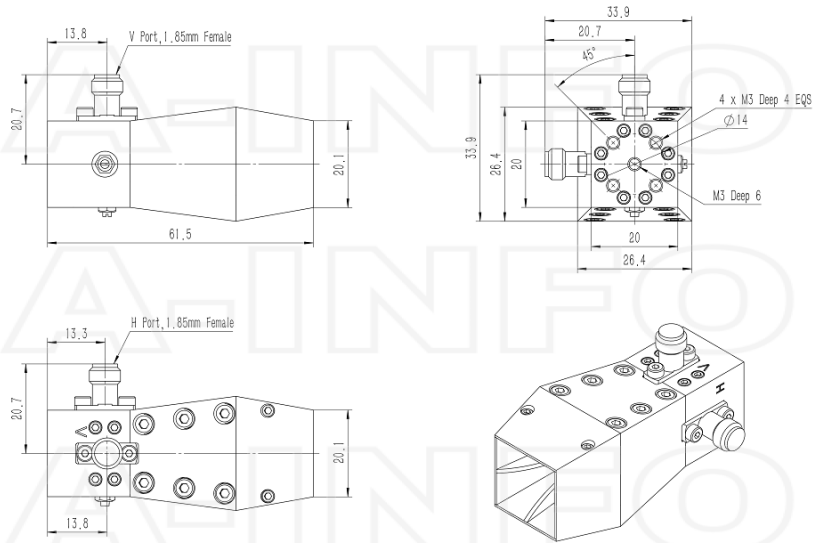

1.85mm-Female Output with L Type Mounting Bracket (Option, P/N: LB-SJ-180400-L)

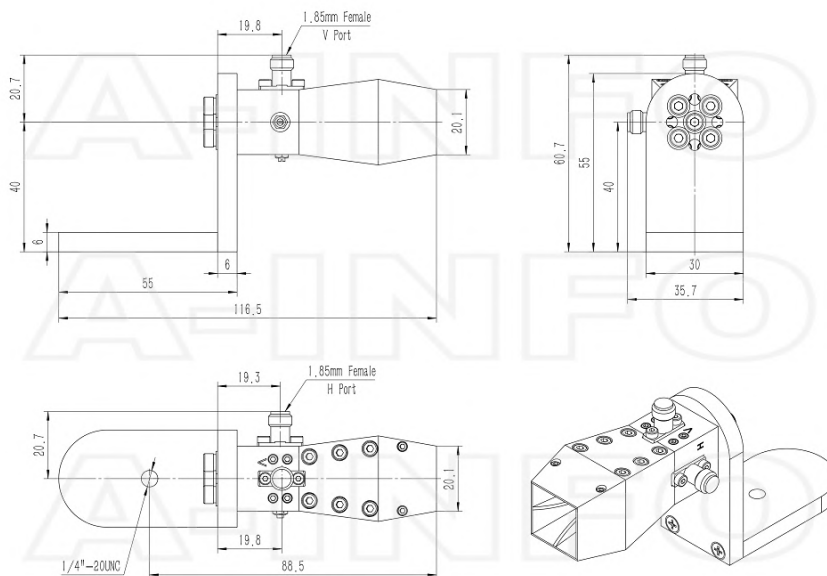

Typical Test Results

Gain

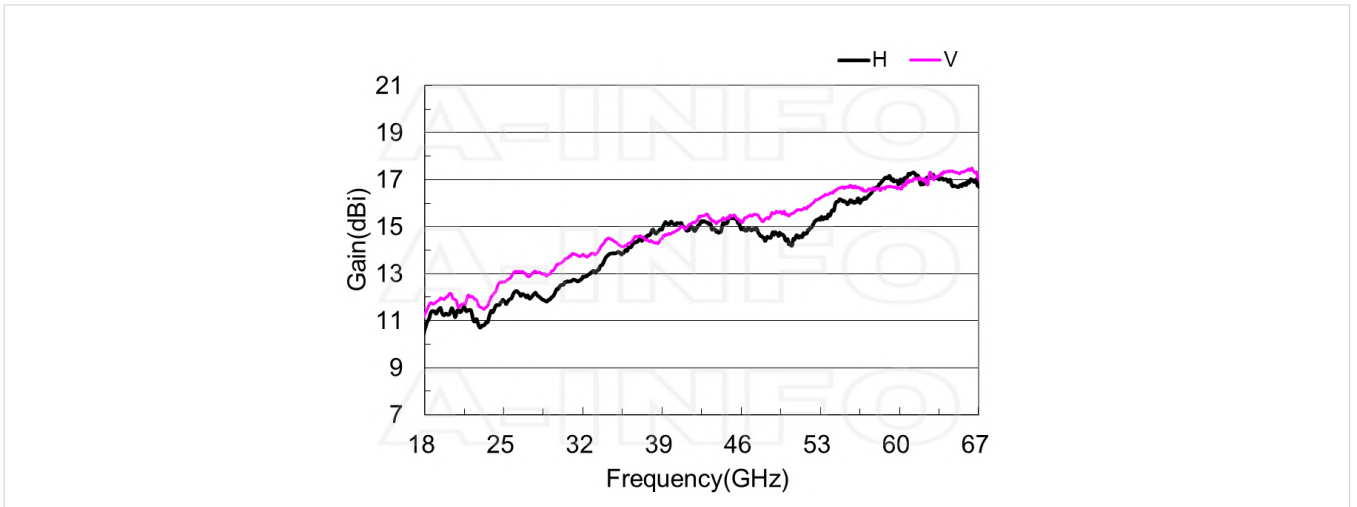

Antenna Factor

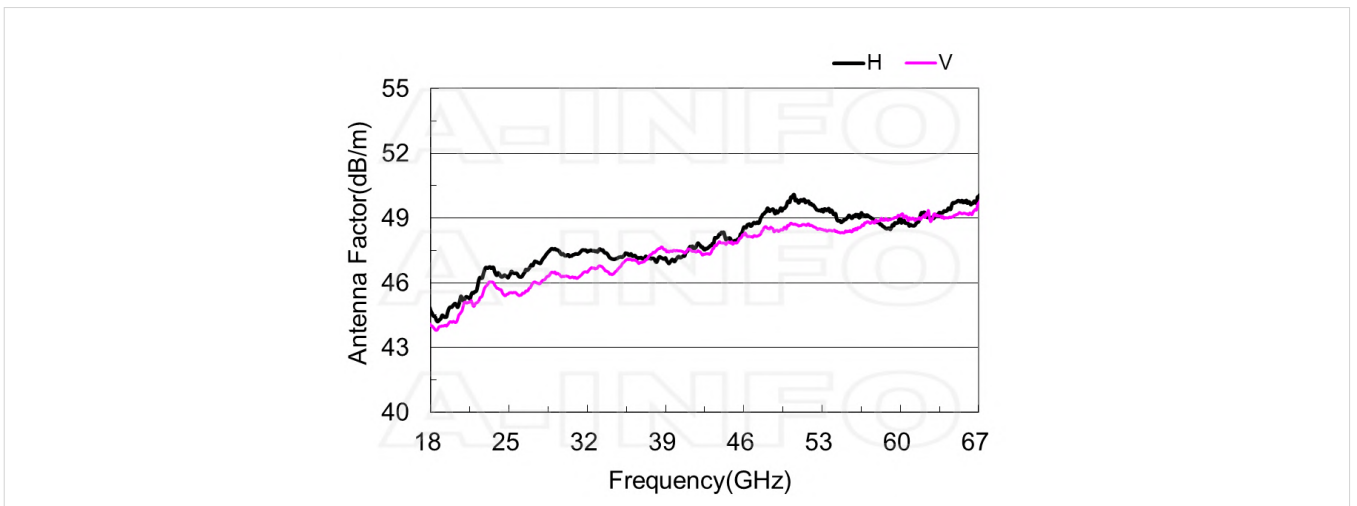

Antenna Factor (Table)

Frequency(GHz)	Horizontal		Vertical	
	Gain(dBi)	AF(dB/m)	Gain(dBi)	AF(dB/m)
18.0	10.63	44.69	11.30	44.01
20.0	11.26	44.97	12.02	44.21
22.0	11.47	45.59	12.01	45.05
24.0	11.35	46.46	12.07	45.75
26.0	12.24	46.27	13.08	45.43
28.0	12.06	47.09	13.04	46.11
30.0	12.50	47.25	13.45	46.31
32.0	12.88	47.43	13.82	46.49
34.0	13.68	47.16	14.44	46.40
36.0	14.09	47.25	14.29	47.05
38.0	14.72	47.09	14.41	47.39
40.0	15.12	47.13	14.75	47.50
42.0	14.90	47.77	15.23	47.45
44.0	14.74	48.34	15.23	47.85
46.0	14.88	48.58	15.26	48.21
48.0	14.53	49.30	15.24	48.59
50.0	14.41	49.78	15.55	48.64
52.0	14.86	49.67	15.86	48.67
54.0	15.68	49.18	16.45	48.41
56.0	16.01	49.16	16.65	48.52
58.0	16.68	48.80	16.61	48.86
60.0	16.89	48.88	16.64	49.13
62.0	16.89	49.17	17.01	49.05
64.0	17.01	49.33	17.31	49.03
66.0	16.91	49.69	17.40	49.20
67.0	16.75	49.99	17.04	49.69

Cross Polarization Isolation

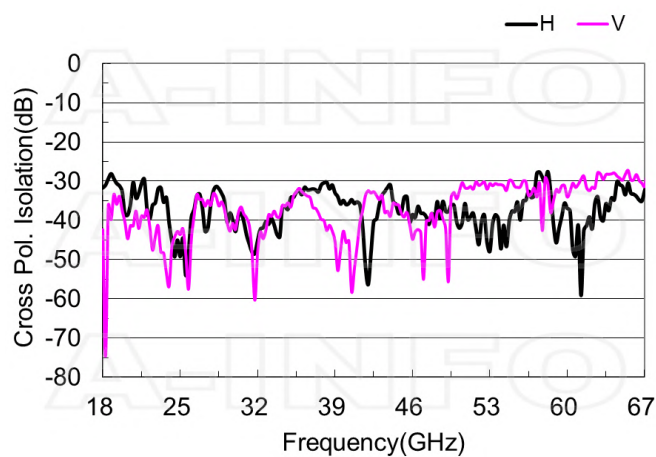

Port to Port Isolation

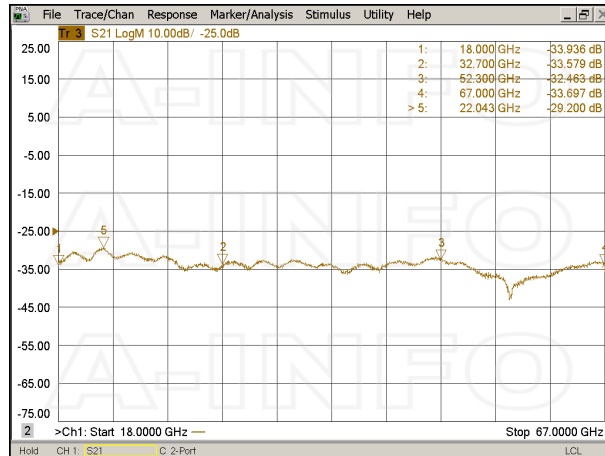

VSWR

Port-H

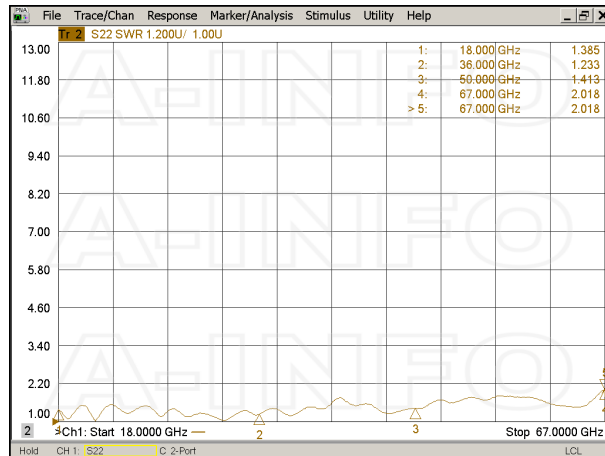

Port-V

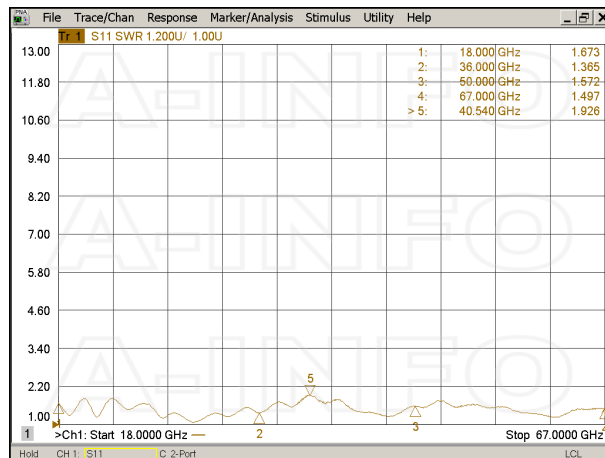

Beamwidth

3dB Beamwidth

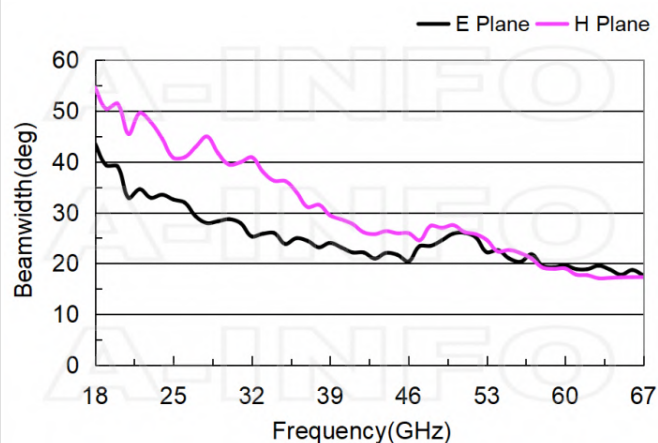

10dB Beamwidth

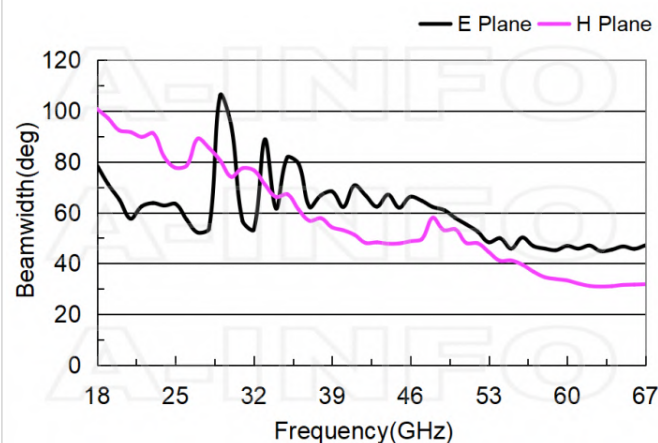

Pattern 1

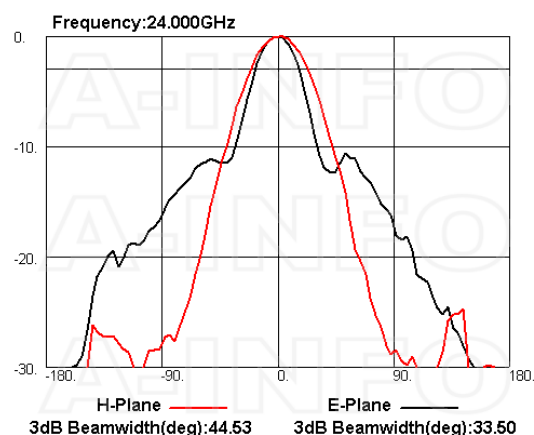
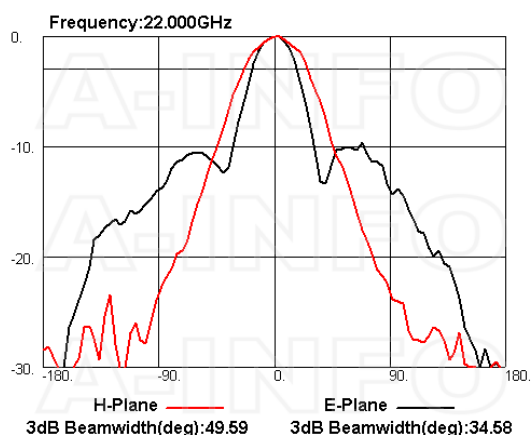
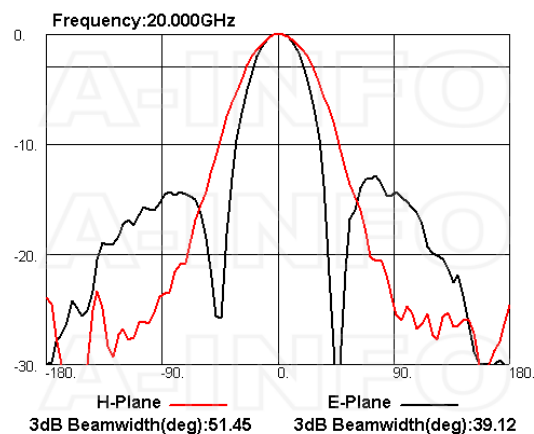
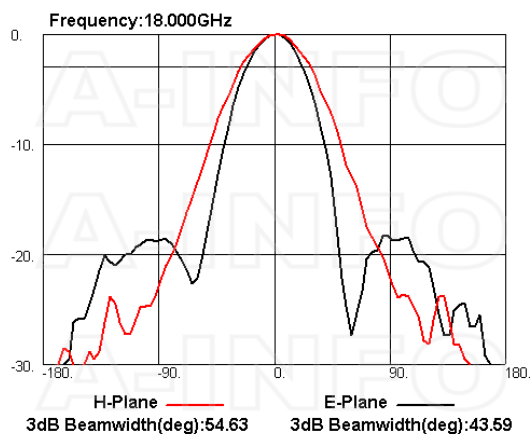

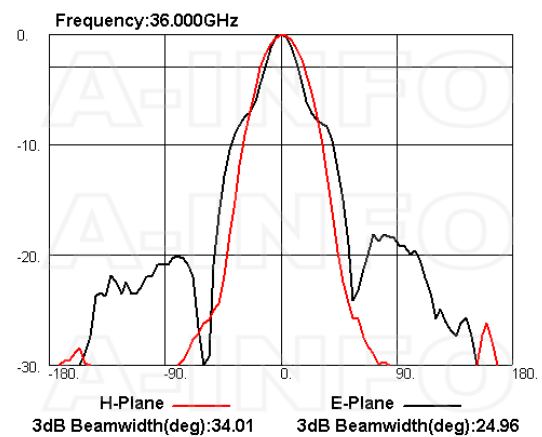
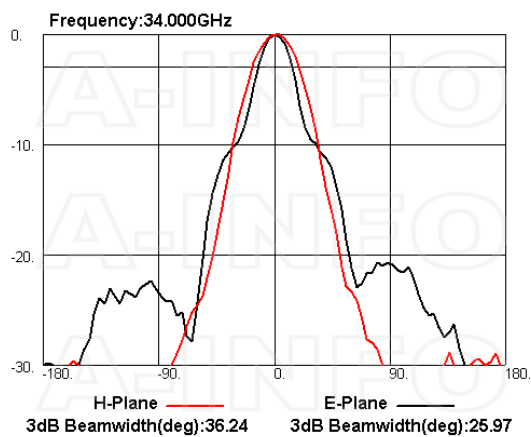
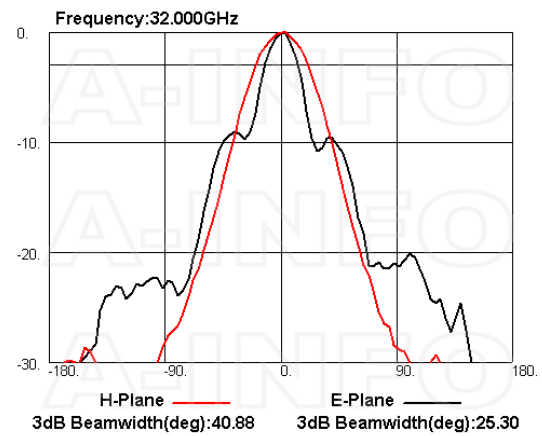
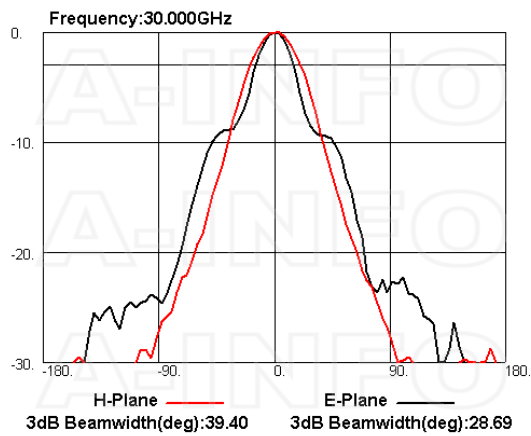
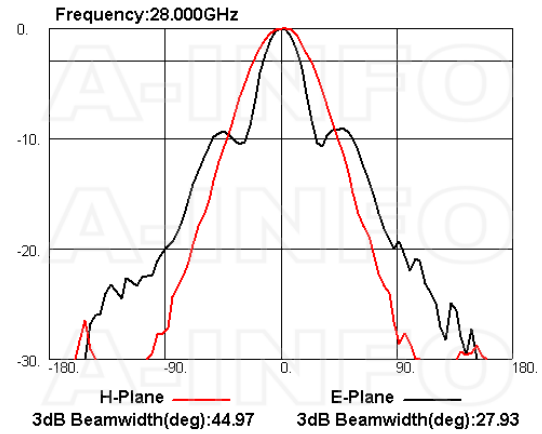
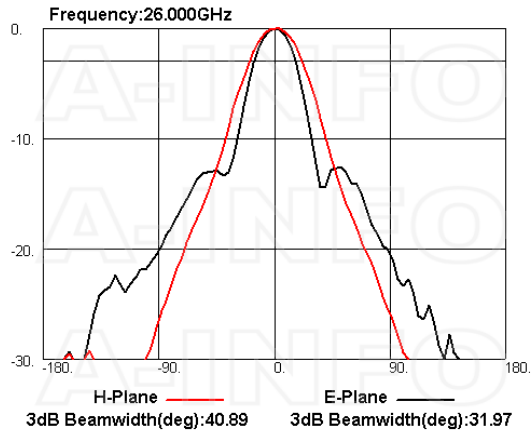

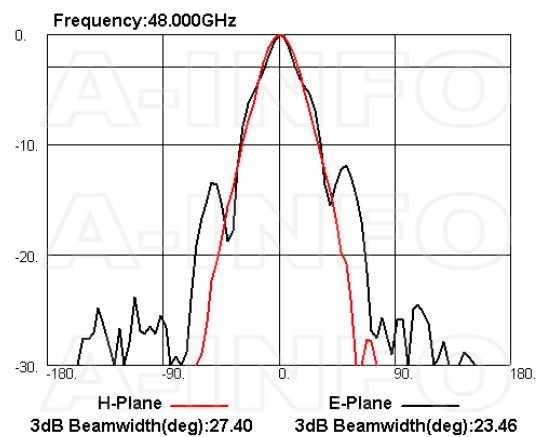
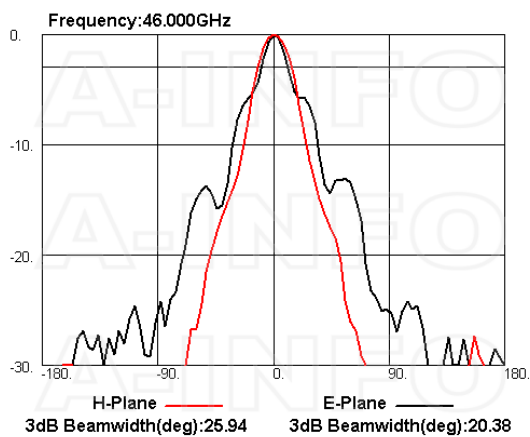
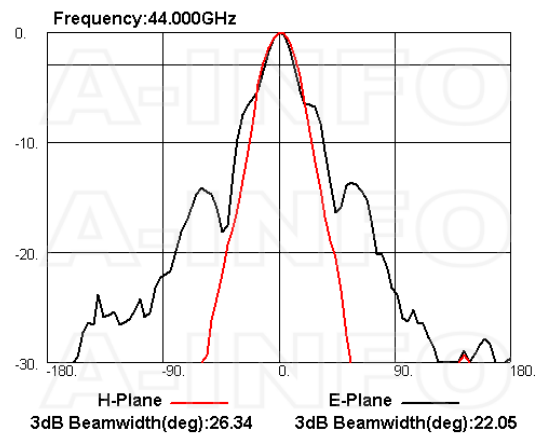
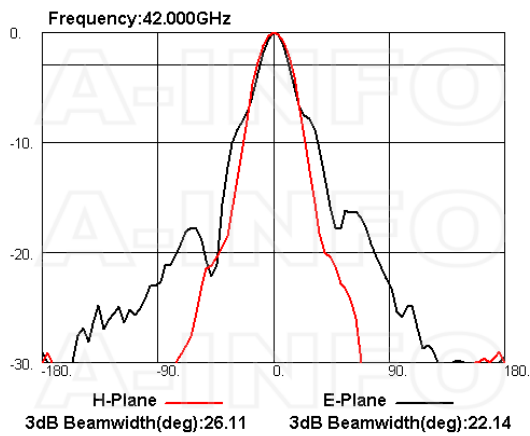
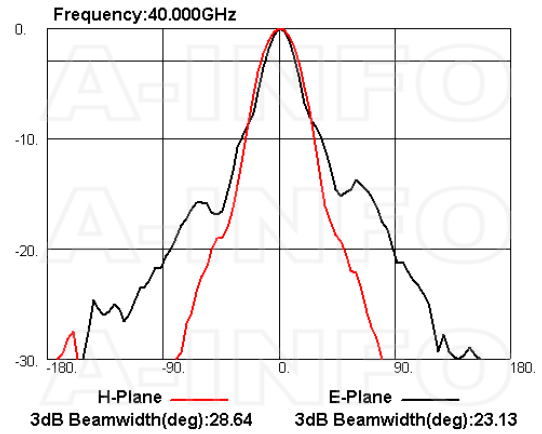
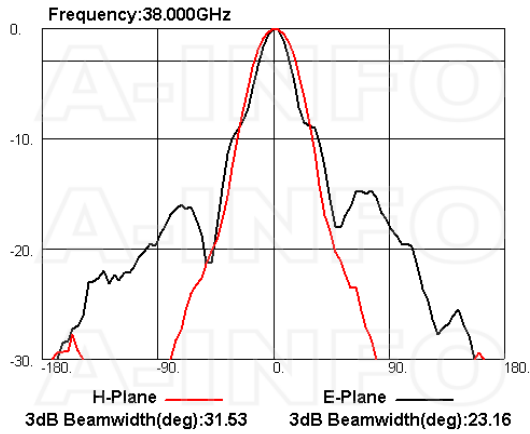

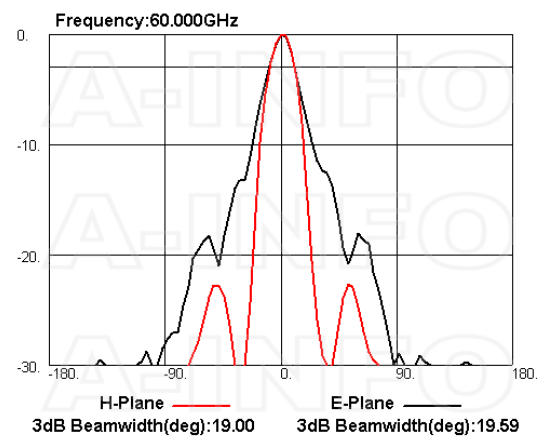
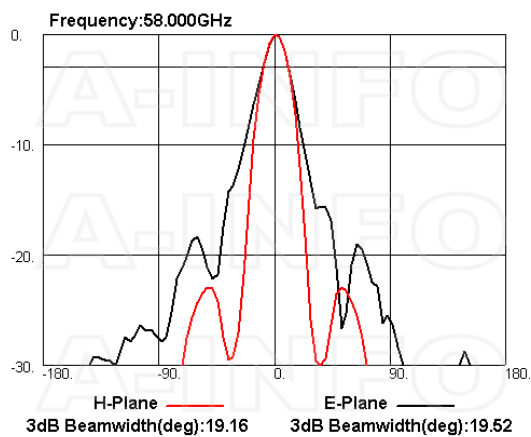
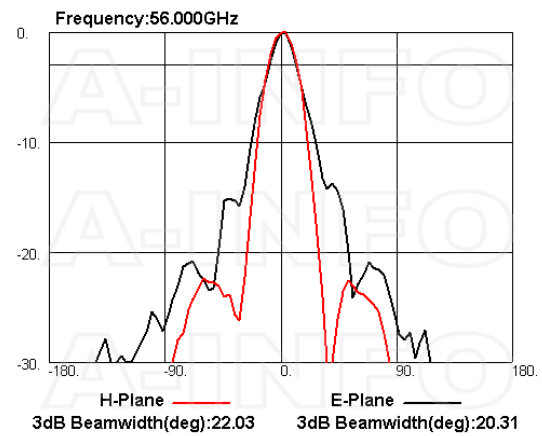
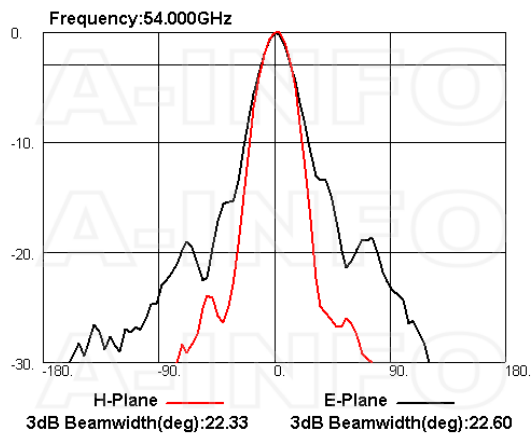
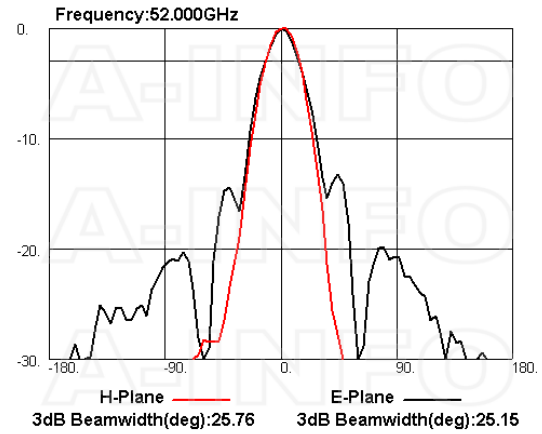
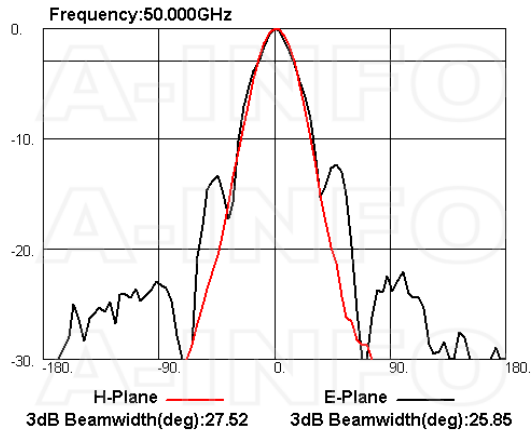

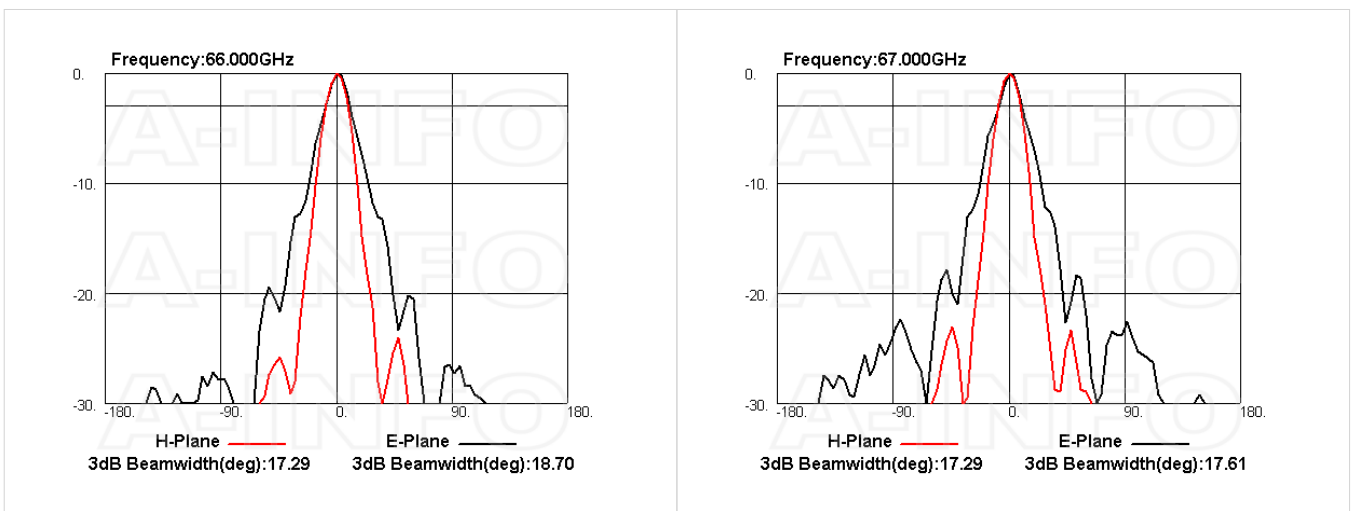
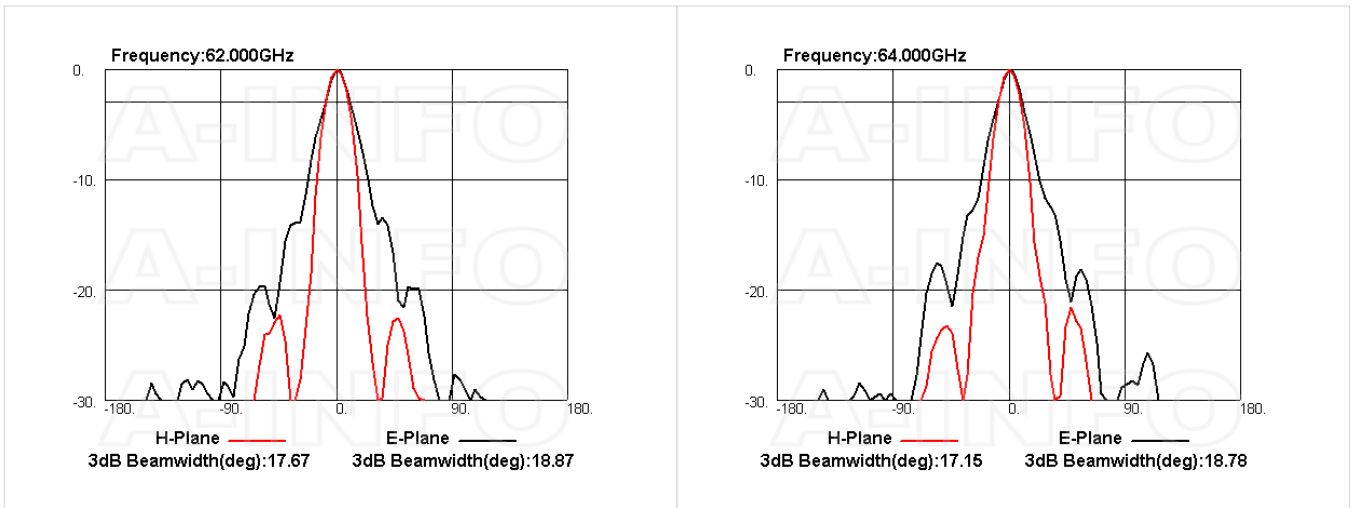

Related Products



LB-SJ-180400-L L Type Mounting Bracket



Tripod_15Kg Al Alloy Tripod



3033HL Wooden Tripod



3033QM Wooden Tripod Metalfree



1.85M-1.85M-B010-200 Flexible Cable Assembly 200mm DC-67GHz 1.85mm Male to 1.85mm Male



1.85M-1.85M-B010-300 Flexible Cable Assembly 300mm DC-67GHz 1.85mm Male to 1.85mm Male



1.85M-1.85M-B010-500 Flexible Cable Assembly 500mm DC-67GHz 1.85mm Male to 1.85mm Male



1.85M-1.85M-B010-1000 Flexible Cable Assembly 1000mm DC-67GHz 1.85mm Male to 1.85mm Male



1.85M-1.85M-B010-1500 Flexible Cable Assembly 1500mm DC-67GHz 1.85mm Male to 1.85mm Male



1.85M-1.85M-B010-2000 Flexible Cable Assembly 2000mm DC-67GHz 1.85mm Male to 1.85mm Male



1.85M-1.85M-B010-3000 Flexible Cable Assembly 3000mm DC-67GHz 1.85mm Male to 1.85mm Male



1.85M-1.85M-B010-5000 Flexible Cable Assembly 5000mm DC-67GHz 1.85mm Male to 1.85mm Male



1.85M-1.85M-B010-10000 Flexible Cable Assembly 10000mm DC-67GHz 1.85mm Male to 1.85mm Male



1.85M-1.85M-B010S-500 Flexible Cable Assembly 500mm DC-67GHz 1.85mm Male to 1.85mm Male



1.85M-1.85M-B010S-1000 Flexible Cable Assembly 1000mm DC-67GHz 1.85mm Male to 1.85mm Male



1.85M-1.85M-B010S-1500 Flexible Cable Assembly 1500mm DC-67GHz 1.85mm Male to 1.85mm Male



1.85M-1.85M-B010S-2000 Flexible Cable Assembly 2000mm DC-67GHz 1.85mm Male to 1.85mm Male



1.85M-1.85M-B010S-3000 Flexible Cable Assembly 3000mm DC-67GHz 1.85mm Male to 1.85mm Male



1.85M-1.85M-B010S-5000 Flexible Cable Assembly 5000mm DC-67GHz 1.85mm Male to 1.85mm Male



1.85M-1.85M-B010S-10000 Flexible Cable Assembly 10000mm DC-67GHz 1.85mm Male to 1.85mm Male



1.85M-1.85F-B010-500 Flexible Cable Assembly 500mm DC-67GHz 1.85mm Male to 1.85mm Female



1.85M-1.85F-B010-1000 Flexible Cable Assembly 1000mm DC-67GHz 1.85mm Male to 1.85mm Female



1.85M-1.85F-B010-1500 Flexible Cable Assembly 1500mm DC-67GHz 1.85mm Male to 1.85mm Female



1.85M-1.85F-B010-2000 Flexible Cable Assembly 2000mm DC-67GHz 1.85mm Male to 1.85mm Female



1.85M-1.85F-B010-2500 Flexible Cable Assembly 2500mm DC-67GHz 1.85mm Male to 1.85mm Female



1.85M-1.85F-B010-3000 Flexible Cable Assembly 3000mm DC-67GHz 1.85mm Male to 1.85mm Female



1.85M-1.85F-B010-5000 Flexible Cable Assembly 5000mm DC-67GHz 1.85mm Male to 1.85mm Female



1.85M-1.85F-B010-10000 Flexible Cable Assembly 10000mm DC-67GHz 1.85mm Male to 1.85mm Female



1.85M-1.85F-B010S-500 Flexible Cable Assembly 500mm DC-67GHz 1.85mm Male to 1.85mm Female



1.85M-1.85F-B010S-1000 Flexible Cable Assembly 1000mm DC-67GHz 1.85mm Male to 1.85mm Female



1.85M-1.85F-B010S-1500 Flexible Cable Assembly 1500mm DC-67GHz 1.85mm Male to 1.85mm Female



1.85M-1.85F-B010S-2000 Flexible Cable Assembly 2000mm DC-67GHz 1.85mm Male to 1.85mm Female



1.85M-1.85F-B010S-3000 Flexible Cable Assembly 3000mm DC-67GHz 1.85mm Male to 1.85mm Female



1.85M-1.85F-B010S-5000 Flexible Cable Assembly 5000mm DC-67GHz 1.85mm Male to 1.85mm Female



1.85M-1.85F-B010S-10000 Flexible Cable Assembly 10000mm DC-67GHz 1.85mm Male to 1.85mm Female

About this Datasheet

<ul style="list-style-type: none">● Product Information <p>Product Link: https://www.ainfoinc.com/lb-sj-180670-1-85f-broadband-dual-polarization-horn-antenna-18-67-ghz-15db-gain-1-85mm-female</p> <p>Data subject to change without notice. © A-INFO INC. 2024. All Rights Reserved</p>	<ul style="list-style-type: none">● Contact Us <p>Address: 60 Tesla, Irvine, CA 92618, USA</p> <p>Website: www.ainfoinc.com</p> <p>Email: sales@ainfoinc.com</p>	<ul style="list-style-type: none">● Phone & Fax <p>Phone: +1-949-639-9688 +1-949-639-9608</p> <p>Fax: +1-949-639-9670</p>
---	---	--